



Bulletin No.: 13036D  
Date: May 2017

# Recall Bulletin

## PRODUCT SAFETY RECALL

**SUBJECT:** Brake Lamp Malfunction

**MODELS:** 2004-2012 Chevrolet Malibu  
2004-2007 Chevrolet Malibu Maxx  
2005-2010 Pontiac G6  
2007-2010 Saturn AURA

The bulletin has been revised to update the Warranty Transaction Information section to include the 14 inch tie strap in Net Item allowance. Please discard all copies of bulletin 13036C.

It is a violation of Federal law for a dealer to deliver a new motor vehicle or any new or used item of motor vehicle equipment (including a tire) covered by this notification under a sale or lease until the defect or noncompliance is remedied.

All involved vehicles that are in dealer inventory must be held and not delivered to customers, dealer traded, or used for demonstration purposes until the repair contained in this bulletin has been performed on the vehicle.

### CONDITION

General Motors has decided that a defect which relates to motor vehicle safety exists in 2004-2012 model year (MY) Chevrolet Malibu, 2004-2007 MY Chevrolet Malibu Maxx, 2005-2010 MY Pontiac G6, 2007-2010 MY Saturn AURA vehicles. On these vehicles, over time an increased resistance can develop in the Body Control Module (BCM) connection system and result in voltage fluctuations or intermittency in the Brake Apply Sensor (BAS) circuit that can cause service brake lamp malfunction. As a result, the service brake lamps may illuminate when the service brakes are not being applied, or may not illuminate when the service brakes are being applied. Additionally, cruise control may not engage. If cruise control is engaged, additional service brake pedal travel may be required to disengage it. Service brake pedal application may not be required to move the shift lever out of PARK, or additional service brake pedal travel may be required to move the shift lever out of PARK. Traction control, electronic stability control, and panic braking assist features, if equipped, may be disabled. Service ESC and/or Traction Control tell-tales may illuminate with this condition. These conditions may increase the risk of a crash.

### CORRECTION

Dealers are to attach the wiring harness to the BCM with a spacer, apply dielectric lubricant to the BCM X2 (C2) connector and the BAS harness connector, and relearn the brake pedal home position. Please see the checklist for all of the required steps for proper repair.

### VEHICLES INVOLVED

All involved vehicles are identified by Vehicle Identification Number on the Investigate Vehicle History screen in GM Global Warranty Management system. Dealership service personnel should always check this site to confirm vehicle involvement prior to beginning any required

inspections and/or repairs. It is important to routinely use this tool to verify eligibility because not all similar vehicles may be involved regardless of description or option content.

For dealers with involved vehicles, a listing with involved vehicles containing the complete vehicle identification number, customer name, and address information has been prepared and will be provided to US and Canadian dealers through the GM GlobalConnect Recall Reports, or sent directly to export dealers. Dealers will not have a report available if they have no involved vehicles currently assigned.

The listing may contain customer names and addresses obtained from Motor Vehicle Registration Records. The use of such motor vehicle registration data for any purpose other than follow-up necessary to complete this recall is a violation of law in several states/provinces/countries. Accordingly, you are urged to limit the use of this report to the follow-up necessary to complete this recall.

### PART INFORMATION

Parts required to complete this recall are to be obtained from General Motors Customer Care and Aftersales (GMCCA). Please refer to your “involved vehicles listing” before ordering parts. This part will be on Order Writing control initially and all DRO’s (Daily Replenishment Orders) will cancel. Dealers can place orders CSO (Customer Special Order). In emergency situations a dealer should place a SPAC case and the orders will be processed in the order received.

<b>Part Number</b>	<b>Description</b>	<b>Quantity/Vehicle</b>
15188763	Retainer-Brk Ped (Short Tie Strap - Pkg of 10)	1
11509086	Strap-EGR Tube (Long Tie Strap - Pkg of 10)	2
Obtain Locally	14 Inch Tie Strap	1 (Submit as Net Item)
13596990	Clip-Wrg Harn (Tie-Down Mount)	1
13596991	Retainer-Acsry Wrg Harn (Rubber Spacer)	1 (If Required)
12378462 – US 10953554 - CA	Promoter, Plastic Adhesion (4 OZ)	As Required (Submit as Net Item)
12377900 – US 10953529 - CA	Lubricant, Dielectric (2 OZ)	As Required (Submit as Net Item)
KENT AUTOMOTIVE 1089482	Woven Polyester Electrical Tape (PET) (Do not order from GMCCA - Obtain Locally)	As Required (Submit as Net Item)

Parts required to complete this recall are to be obtained from General Motors Customer Care and Aftersales (GMCC&A). Please refer to your “involved vehicles listing” before ordering parts. Normal orders should be placed on a DRO = Daily Replenishment Order. In an emergency situation, parts should be ordered on a CSO = Customer Special Order.

\*Contact Kent Automotive at 1-888-937-5368, or [www.kent-automotive.com](http://www.kent-automotive.com). Dealers that do not have a Kent Automotive account or representative must advise the Customer Service Representative that the part(s) is being used for this GM bulletin to obtain special bulletin pricing. Do not order from GMCCA.

Reminder: Parts may be removed from Retail Inventory Management (RIM) management. Dealers should review the affected parts to confirm RIM managed status. Parts may have quantity limiters in effect.

## SERVICE PROCEDURE

### **Service Procedure Checklist**

The following checklist is ONLY intended to supplement recall bulletin 13036. It is NOT designed to replace the service information. This checklist assumes that you have read, understand, and will closely follow all of the steps in the recall bulletin to ensure a proper repair. Please use this as a guide while performing the recall bulletin to ensure ALL of the required repairs are performed.

- Perform a terminal drag test on the brake pedal position sensor (BPPS) cavity terminals.
- Apply dielectric lubricant to brake pedal position sensor (BPPS) cavity terminals.
- Apply dielectric lubricant to BPPS connector.
- Cut off existing gray tie strap to obtain more wiring harness slack for BCM connection.
- Remove tie strap from BCM connector X2 (C2) harness.
- Install NEW tie straps to BCM connector X2 (C2) harness.
- Perform a terminal drag test on BCM connector X2 (C2) terminals 18, 31, and 59.
- Apply dielectric lubricant to BCM terminals in cavity X2 (C2).
- Apply dielectric lubricant to connector face of BCM connector X2 (C2).
- Apply adhesion promoter, install tie-down mount, tie strap and rubber spacer to upper corner of BCM (Pontiac G6, Saturn AURA, and 2008-2012 Chevrolet Malibu)
- Clean the surface of the IP Mag Beam using an alcohol wipe, apply adhesion promoter, install tie-down mount and tie straps to IP Mag Beam (rubber spacer is not needed for the following models) (2004-2007 Chevrolet Malibu Sedan and Maxx, and 2008 Chevrolet Malibu Classic)
- Perform the brake pedal position sensor calibration.

## Dielectric Lubricant Application Procedure (All Models)

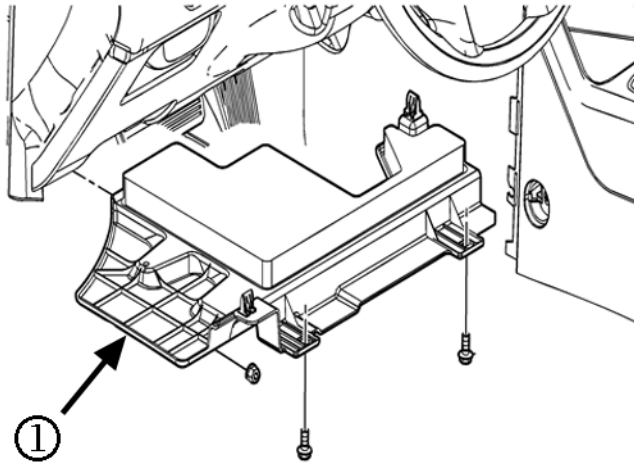

3963176

1. Remove the driver side instrument panel insulator panel (1). Refer to *Instrument Panel Insulator Replacement - Left Side* in SI.

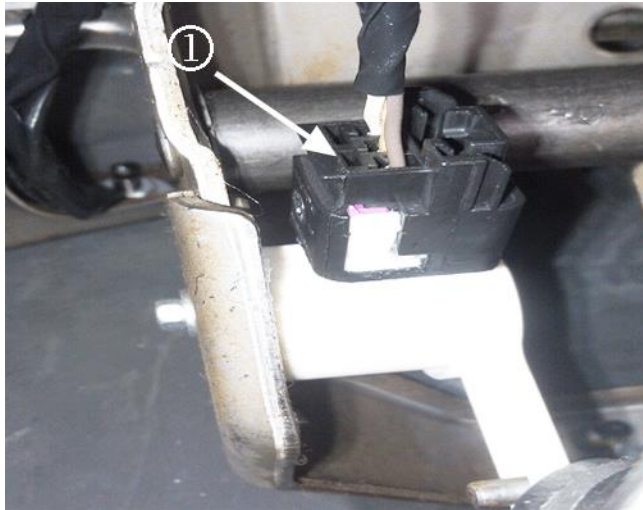

3963182

2. Disconnect the Brake Pedal Position Sensor (BPPS) connector (1).

**Caution:** ONLY use test leads from J-35616-F, GM Terminal Test Probe Kit, to front probe terminals. Do not insert test equipment probes (DMM etc.) into any connector or fuse block terminal. Do not use paper clips or other substitutes to probe terminals. The diameter of an incorrect test probe will deform most female terminals. A deformed terminal will result in a poor connection and system failure.

When using the J-35616-F GM Terminal Test Probe Kit, ensure the terminal diagnostic test probe is the correct size for the connector terminal. Do not visually choose the terminal diagnostic test probe because some connector terminal cavities may appear larger than the actual terminal in the cavity. Refer to the connector end view in SI or the label inside of the J-35616-F GM Terminal Test Probe Kit cover to ensure the correct terminal diagnostic test probe is selected.

3. Using terminal adapter J-35616-2A (GY), perform a terminal drag test on the BPPS connector terminals. Verify that the retention force is significantly different between a known good terminal and the suspect terminal. Replace any female terminal(s) in question.



4694672

4. Using the applicator stick, apply a smaller 5 mm x 5 mm x 5 mm dab of dielectric lubricant completely across all of the terminal pins in the BPPS connector cavity.
5. Use a one-inch nylon bristle brush to spread the lubricant evenly onto all terminal pins.



4694680

6. Apply a 5 mm x 5 mm x 5 mm dab of dielectric lubricant completely across the connector face of the BPPS connector.
7. Use a one-inch nylon bristle brush to spread the lubricant evenly into all terminal holes.
8. Reconnect the connector back on the BPPS.

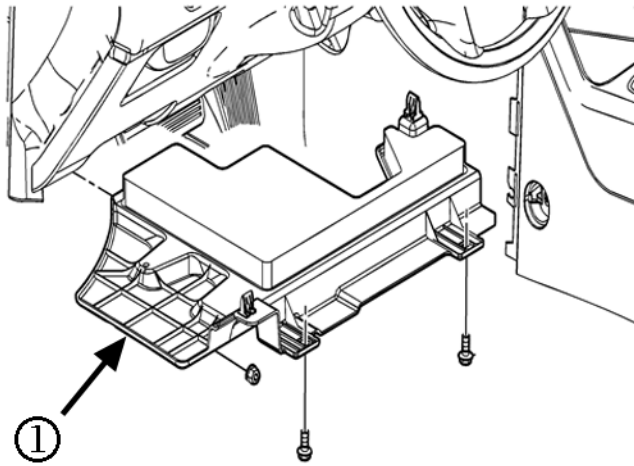

3963176

9. Reinstall the driver side instrument panel insulator panel (1). Refer to *Instrument Panel Insulator Replacement - Left Side* in SI.

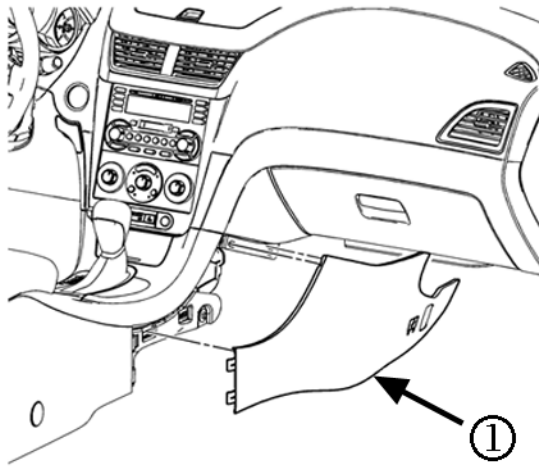

3963121

10. Remove the right side front floor console side trim panel (1) to access the Body Control Module (BCM).



3684285

11. Unlatch the X2 (C2) connector (1) and disconnect the connector from the BCM.

**Caution:** ONLY use test leads from J-35616-F, GM Terminal Test Probe Kit, to front probe terminals. Do not insert test equipment probes (DMM etc.) into any connector or fuse block terminal. Do not use paper clips or other substitutes to probe terminals. The diameter of an incorrect test probe will deform most female terminals. A deformed terminal will result in a poor connection and system failure.

When using the J-35616-F GM Terminal Test Probe Kit, ensure the terminal diagnostic test probe is the correct size for the connector terminal. Do not visually choose the terminal diagnostic test probe because some connector terminal cavities may appear larger than the actual terminal in the cavity. Refer to the connector end view in SI or the label inside of the J-35616-F GM Terminal Test Probe Kit cover to ensure the correct terminal diagnostic test probe is selected.

12. Using terminal adapter J-35616-64B (L-BU), perform a terminal drag test on BCM X2 (C2) connector terminals 18, 31, and 59. Verify that the retention force is significantly different between a known good terminal and the suspect terminal. Replace any female terminal(s) in question.

13. Remove the blue latch cover from the connector.



4694681

**Caution:** Be careful not to damage the harness when cutting the tie strap push pin.

14. Remove the tie strap push pin (1) from the instrument panel and cut it off of the BCM harness using side cutters. This will allow more wiring harness slack.

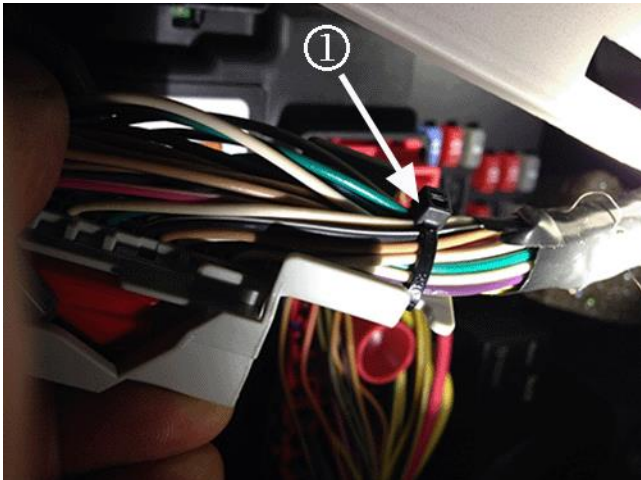

4234863

15. To allow for installation of the tie strap added in the next step, remove the existing tie strap (1) from the end of the connector.



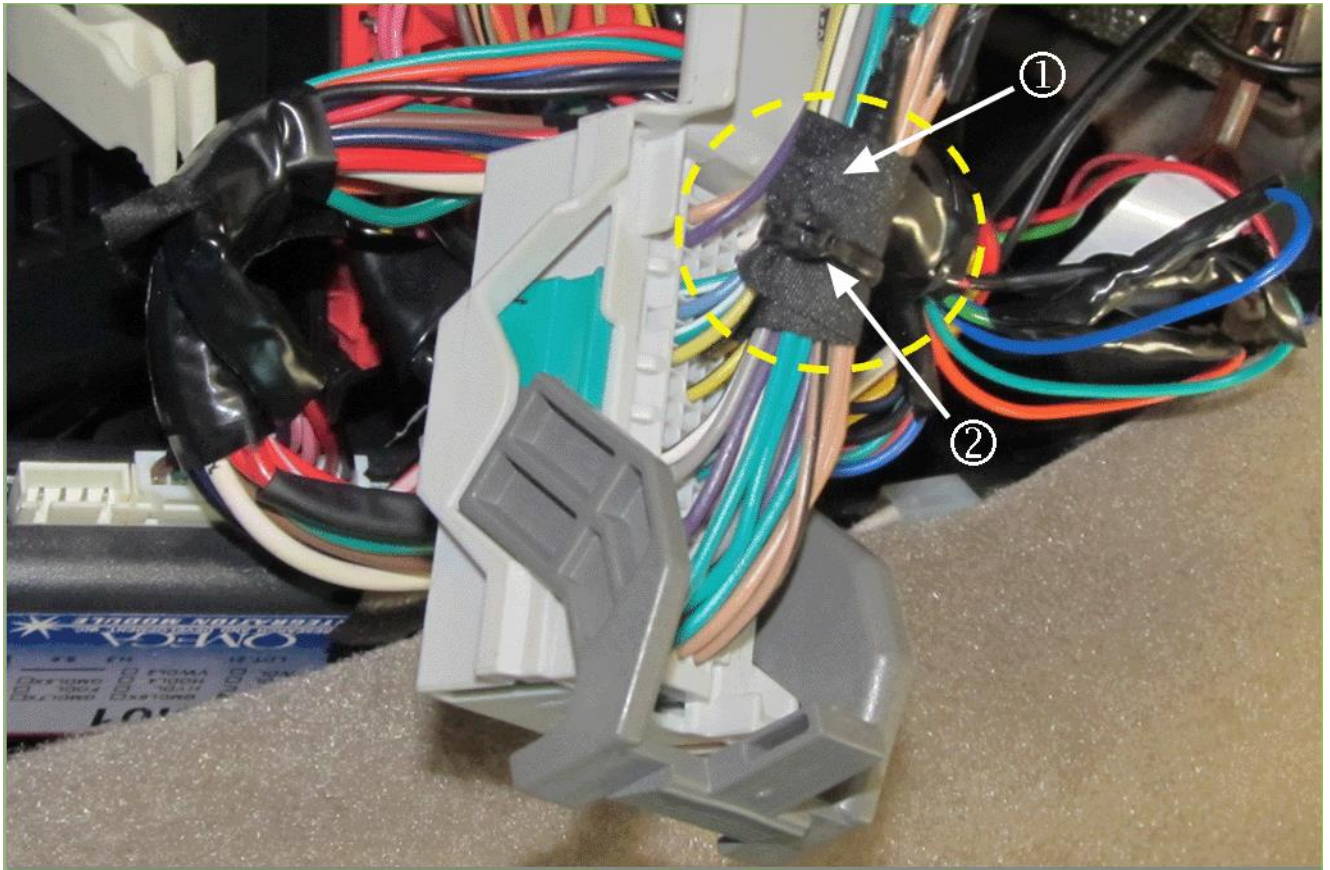

3963132

**Important:** ONLY use non-abrasion Woven Polyester Electrical Tape (PET). Do NOT use vinyl electrical tape.

**Note:** You will not be able to tie strap the complete bundle of wiring; exclude approximately the first three rows of the wiring bundle.

- 16. Install Kent Automotive non-abrasion Woven Polyester Electrical Tape (PET) (1) and a new (short) tie strap (2) to the wiring within the BCM connector bundle.

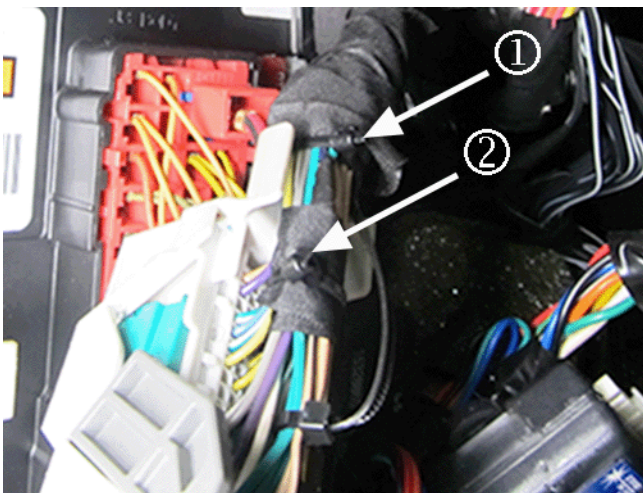

4234876

- 17. Once the additional short tie strap (2) is added, apply PET and install a new long tie strap (1) at the location where original tie strap was removed.



4694685

- 18. Using the applicator stick, apply a 10 mm x 10 mm x 10 mm dab of dielectric lubricant completely across all of the terminal pins in the BCM connector cavity.

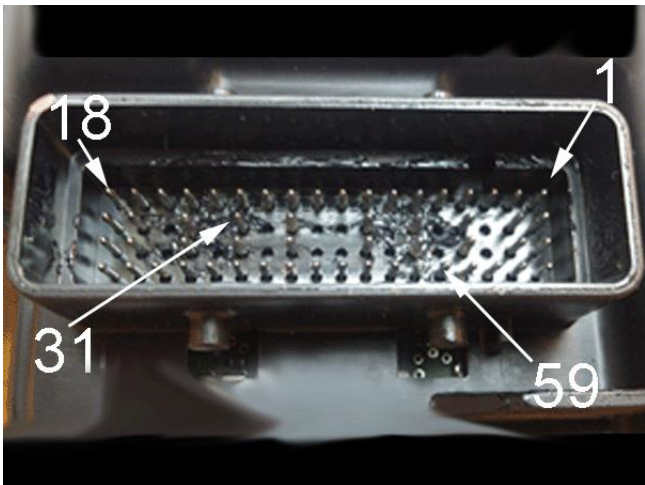

3763821

**Note:** Terminal 1 is called out for reference ONLY.

- 19. Apply a 10 mm dab of dielectric lubricant (clear gel) completely across all of the terminal pins for connector X2 (C2) in the BCM. Verify that terminal pins 18, 31, & 59 are thoroughly coated.

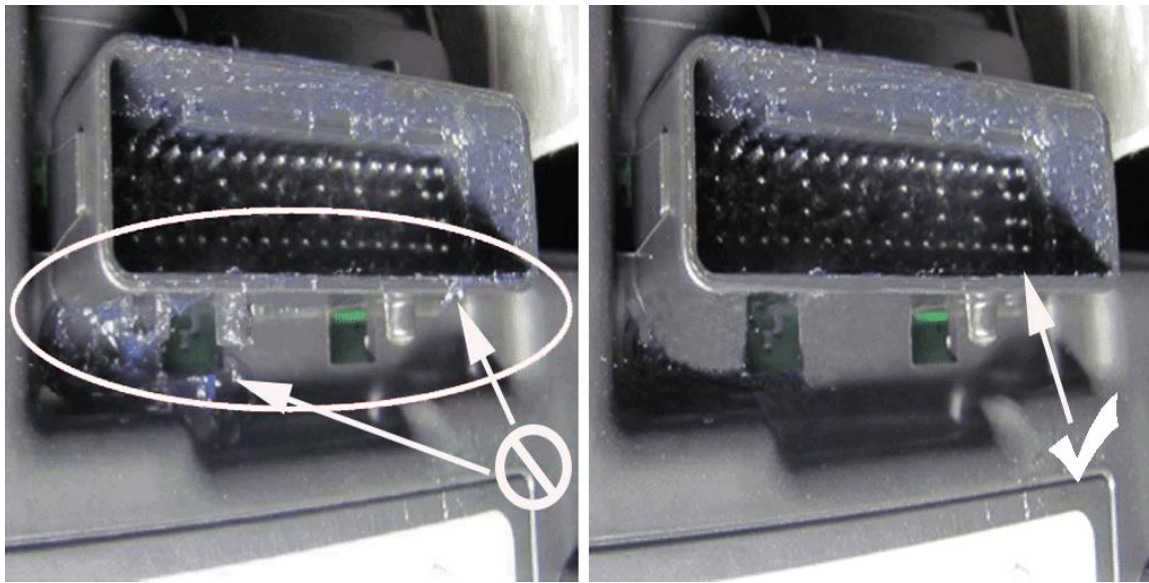

**Note:** Do NOT apply dielectric lubricant outside of the cavity for connector X2 (C2) in the BCM.

20. Use a one-inch nylon bristle brush to spread the lubricant evenly onto all terminal pins.
21. Again using the applicator stick, apply a 10 mm dab of dielectric lubricant completely across the X2 (C2) connector face of the BCM connector.

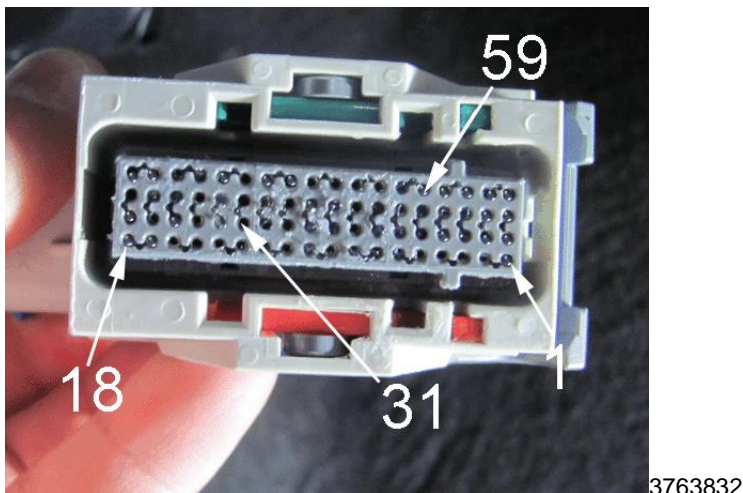

22. Use a one-inch nylon bristle brush to spread the lubricant evenly into all terminal holes. Verify that terminal locations 18, 31, & 59 are thoroughly coated.
23. Reinstall the blue latch cover to connector X2 (C2), reconnect the connector back on the BCM and re-latch.
24. Wipe away any excess lubricant.
25. Apply pressure to connector X2 (C2) to verify it is fully seated.
26. Depending on vehicle model, follow the appropriate *BCM Harness Tie Strap Installation Procedure* below.

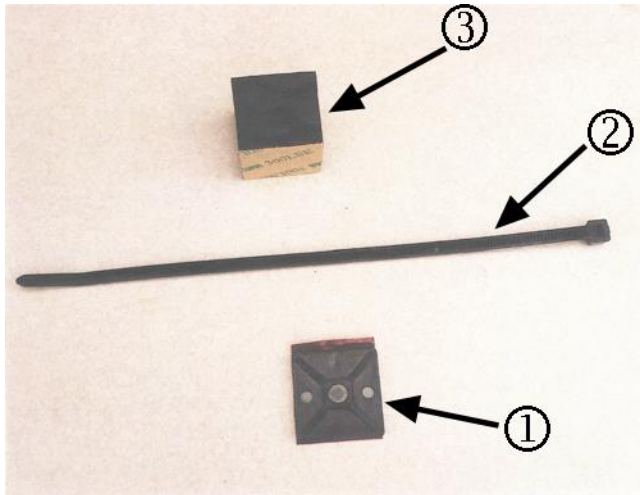
**BCM Harness Tie Strap Installation Procedure****(Pontiac G6, Saturn AURA, and 2008-2012 Chevrolet Malibu)**

3963139

**Note:** The new tie-down mount (1), tie strap (2) and rubber spacer (3) will be added to secure the harness at the upper forward corner of the BCM.

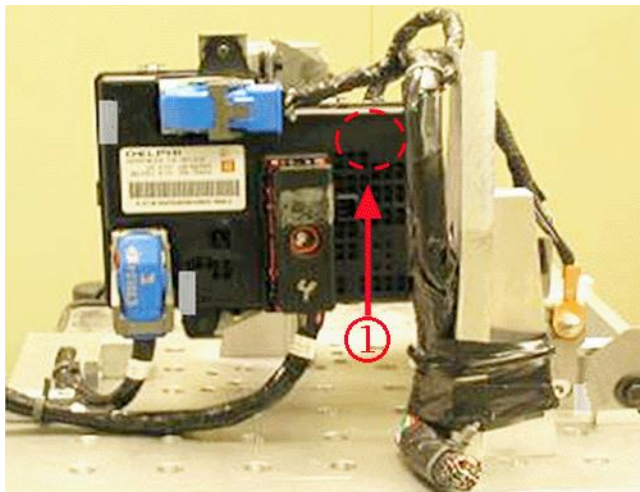

3963147

1. Install the new tie down clip to the outboard, upper forward corner (1) of the BCM housing.
  - 1.1. Carefully apply GM Plastic Adhesion Promoter the upper forward corner of the BCM.

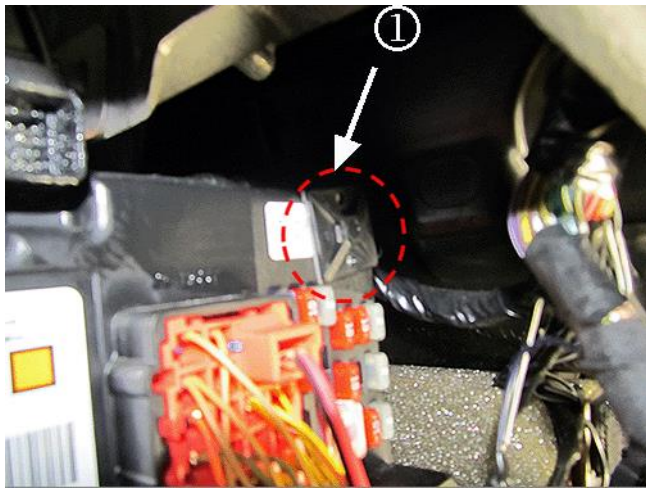

3963151

**Note:** Ensure the orientation of the clip is such that the slot is in the vertical direction to accept the tie strap.

- 1.2. Peel the backing from the adhesive on the tie down mount (1) and install the mount to the BCM. Let the promoter and adhesive set up while applying the dielectric lubricant and tape.



4694689

2. Apply Kent Automotive non-abrasion PET to the BCM harness, covering the tie strap just outside the X2 (C2) connector, and extending to 25 mm (1 in) past the forward corner of the BCM as shown.

**Note:** Be sure to carefully cinch the tie strap completely so the harness is secured.

3. Stack the new rubber spacer (2) on top of the tie-down mount (3) (installed previously), position the BCM harness across the spacer, install the long tie strap (4) through the slot on the mount and carefully cinch the tie strap.

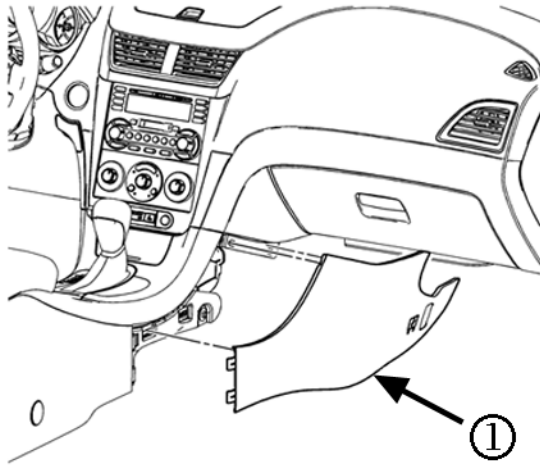

3963121

4. Reinstall the right side front floor console side trim panel (1).
5. Perform the brake pedal position sensor calibration. Refer to *Brake Pedal Position Sensor Calibration* in SI.
6. Verify proper operation of the brake lights.

**BCM Harness Tie Strap Installation Procedure****(2004-2007 Chevrolet Malibu Sedan and Maxx, and 2008 Chevrolet Malibu Classic)**

1. Clean the surface of the IP Mag Beam using an alcohol wipe.
2. Carefully apply GM Plastic Adhesion Promoter to the IP Mag Beam.

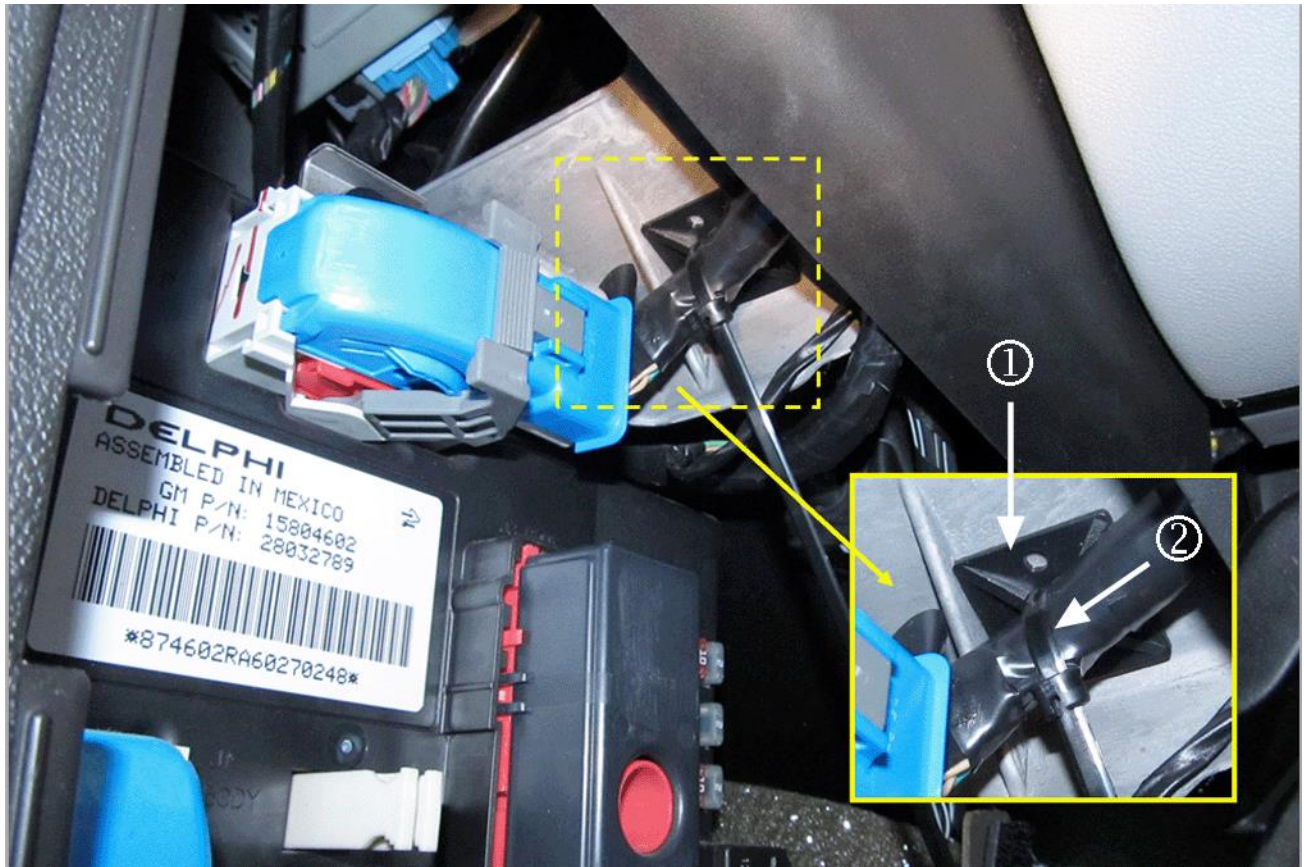

3963167

**Note:** DO NOT install the rubber spacer on the mount.

3. Peel the backing from the adhesive on the tie-down mount and install the mount (1) to the flat underside surface of IP Mag Beam, in the location shown in the graphic above.

**Note:** Be sure to carefully cinch the tie strap completely so the harness is secured.

4. Position the harness to the mount, install the long tie strap (2) through the slot on the mount, and carefully cinch the tie strap.



4694690

5. Install a long tie strap around the IP Mag Beam and the harness and carefully cinch the tie strap.

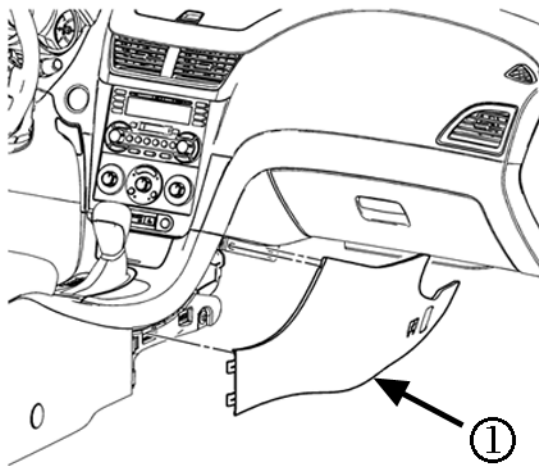

3963121

6. Reinstall the right side front floor console side trim panel (1).
7. Perform the brake pedal position sensor calibration. Refer to *Brake Pedal Position Sensor Calibration* in SI.
8. Verify proper operation of the brake lights.



### CUSTOMER REIMBURSEMENT - For US

Customer requests for reimbursement of previously paid repairs for the recall condition are to be submitted to the dealer by August 31, 2015, unless otherwise specified by state law. If this is not convenient for the customer, the customer may mail the completed Customer Reimbursement Request Form and all required documents to the GM Customer Assistance Center.

**All reasonable and customary costs to correct the condition described in this bulletin should be considered for reimbursement. Any questions or concerns should be reviewed with your GM representative prior to processing the request.**

When a customer requests reimbursement, they must provide the following:

- A completed Customer Reimbursement Request Form. This form is mailed to the customer or can be obtained through GM GlobalConnect.
- The name and address of the person who paid for the repair.
- Paid receipt confirming the amount of the repair expense, a description of the repair, and the person or entity performing the repair.

**IMPORTANT:** GM requires dealers to approve or deny a reimbursement request within 30 days of receipt. If a reimbursement request is approved, the dealer should immediately issue a check to the customer and submit an appropriate warranty transaction for the incurred expense. If a reimbursement request is denied, the dealer MUST provide the customer with a clear and concise explanation, in writing, as to why the request was denied. The bottom portion of the Customer Reimbursement Request Form may be used for this purpose. If the denial was due to missing documents, the customer can resubmit the request when the missing documents are obtained, as long as it is still within the allowed reimbursement period.

Warranty transactions for customer reimbursement of previously paid repairs are to be submitted as required by GM Global Warranty Management. Additional information can also be found in Warranty Administration Bulletin 11-00-89-004.

### CUSTOMER REIMBURSEMENT - For Canada and Export

Customer requests for reimbursement of previously paid repairs to correct the condition described in this bulletin are to be submitted to the dealer prior to or by August 31, 2015.

When a customer requests reimbursement, they must provide the following:

- Proof of ownership at time of repair.
- Original paid receipt confirming the amount of unreimbursed repair expense(s) (including Service Contract deductibles), a description of the repair, and the person or entity performing the repair.

All reasonable and customary costs to correct the condition described in this bulletin should be considered for reimbursement. Any questions or concerns should be reviewed with your GM representative prior to processing the request.

COURTESY TRANSPORTATION – For US and Canada

The General Motors Courtesy Transportation program is intended to minimize customer inconvenience when a vehicle requires a repair that is covered by the New Vehicle Limited Warranties. The availability of courtesy transportation to customers whose vehicles are within the warranty coverage period and involved in a product program is very important in maintaining customer satisfaction. Dealers are to ensure that these customers understand that shuttle service or some other form of courtesy transportation is available and will be provided at no charge. Dealers should refer to the General Motors Service Policies and Procedures Manual for Courtesy Transportation guidelines.

WARRANTY TRANSACTION INFORMATION

Labor Operation	Description	Labor Time	Trans. Type	Net Item
9100810	BCM and BPPS Harness and Connector Repair	0.5	ZFAT	*
9100822	Customer Reimbursement Approved - For USA and Canada dealers only - For Export dealers only	N/A 0.2	ZFAT	**
9100823	Customer Reimbursement Denied – For USA dealers only	N/A	ZFAT	***

**Note:** To avoid having to “H” route the customer reimbursement transaction for approval, it must be submitted prior to the repair transaction.

- \* The amount identified in “Net Item” should represent the actual sum total of the current GMCCA dealer net price for 14 inch Tie Strap, plastic Adhesion Promoter, Dielectric Lubricant and Woven Polyester Electrical Tape needed to perform the required repairs, not to exceed \$1.12 USD, \$1.20CAD, plus applicable Mark-Up or Landed Cost (for Export).
- \*\* For USA and Canada: Submit the dollar amount reimbursed to the customer in Net/Reimbursement. Submit \$20.00 administrative allowance in Net/Admin Allowance.  
For Export: Submit the dollar amount reimbursed to the customer in Net/Reimbursement.
- \*\*\* Submit \$10.00 administrative allowance in Net/Admin Allowance.

**Note:** Customer reimbursement will not close this recall. The service procedure must also be performed on the vehicle.

CUSTOMER NOTIFICATION – For US and Canada

General Motors will notify customers of this recall on their vehicle (see copy of customer letter included with this bulletin).

CUSTOMER NOTIFICATION – For Export

Letters will be sent to known owners of record located within areas covered by the US National Traffic and Motor Vehicle Safety Act. For owners outside these areas, dealers should notify customers using the attached sample letter.

## DEALER RECALL RESPONSIBILITY – For US and Export (US States, Territories, and Possessions)

It is a violation of Federal law for a dealer to deliver a new motor vehicle or any new or used item of motor vehicle equipment (including a tire) covered by this notification under a sale or lease until the defect or noncompliance is remedied.

The US National Traffic and Motor Vehicle Safety Act provides that each vehicle that is subject to a recall of this type must be adequately repaired within a reasonable time after the customer has tendered it for repair. A failure to repair within sixty days after tender of a vehicle is prima facie evidence of failure to repair within a reasonable time. If the condition is not adequately repaired within a reasonable time, the customer may be entitled to an identical or reasonably equivalent vehicle at no charge or to a refund of the purchase price less a reasonable allowance for depreciation. To avoid having to provide these burdensome remedies, every effort must be made to promptly schedule an appointment with each customer and to repair their vehicle as soon as possible. In the recall notification letters, customers are told how to contact the US National Highway Traffic Safety Administration if the recall is not completed within a reasonable time.

## DEALER RECALL RESPONSIBILITY – All

All unsold new vehicles in dealers' possession and subject to this recall must be held and inspected/repaired per the service procedure of this recall bulletin before customers take possession of these vehicles.

Dealers are to service all vehicles subject to this recall at no charge to customers, regardless of mileage, age of vehicle, or ownership, from this time forward.

Customers who have recently purchased vehicles sold from your vehicle inventory, and for which there is no customer information indicated on the dealer listing, are to be contacted by the dealer. Arrangements are to be made to make the required correction according to the instructions contained in this bulletin. A copy of the customer letter is provided in this bulletin for your use in contacting customers. Recall follow-up cards should not be used for this purpose, since the customer may not as yet have received the notification letter.

In summary, whenever a vehicle subject to this recall enters your vehicle inventory, or is in your dealership for service in the future, you must take the steps necessary to be sure the recall correction has been made before selling or releasing the vehicle.



# IMPORTANT SAFETY RECALL

August 2014

Dear General Motors Customer:

This notice is sent to you in accordance with the National Traffic and Motor Vehicle Safety Act.

General Motors has decided that a defect which relates to motor vehicle safety exists in 2004-2012 model year (MY) Chevrolet Malibu, 2004-2007 MY Chevrolet Malibu Maxx, 2005-2010 MY Pontiac G6, 2007-2010 MY Saturn Aura vehicles. As a result, GM is conducting a safety recall. We apologize for this inconvenience. However, we are concerned about your safety and continued satisfaction with our products.

## IMPORTANT

- This notice applies to your vehicle.
- Your vehicle is involved in GM safety recall 13036.
- Schedule an appointment with your GM dealer.
- This service will be performed for you at **no charge**.

### Why is your vehicle being recalled?

On these vehicles, over time an increased resistance can develop in the Body Control Module (BCM) connection system and result in voltage fluctuations or intermittency in the Brake Apply Sensor (BAS) circuit that can cause service brake lamp malfunction. As a result, the service brake lamps may illuminate when the service brakes are not being applied, or may not illuminate when the service brakes are being applied. Additionally, cruise control may not engage. If cruise control is engaged, additional service brake pedal travel may be required to disengage it. Service brake pedal application may not be required to move the shift lever out of PARK, or additional service brake pedal travel may be required to move the shift lever out of PARK. Traction control, electronic stability control, and panic braking assist features, if equipped, may be disabled. Service ESC and/or Traction Control tell-tales may illuminate with this condition. These conditions may increase the risk of a crash.

### What will we do?

Your GM dealer will attach your vehicle's wiring harness to the BCM with a spacer, apply dielectric lubricant to both the BCM and harness connector and on the BAS and harness connector, and relearn the brake pedal home position. This service will be performed for you at **no charge**. Because of service scheduling requirements, it is likely that your dealer will need your vehicle longer than the actual service correction time of approximately 20 minutes.

### What should you do?

You should contact your GM dealer to arrange a service appointment as soon as possible.

**Did you already pay for this repair?**

Even though you may have already had repairs for this condition corrected, you will still need to take your vehicle to your dealer for additional repairs. If you have paid for repairs for the recall condition, please complete the enclosed reimbursement form and present it to your dealer with all required documents. Working with your dealer will expedite your request, however, if this is not convenient, you may mail the completed reimbursement form and all required documents to Reimbursement Department, PO Box 33170, Detroit, MI 48232-5170. The completed reimbursement form and required documents must be presented to your dealer or received by the Reimbursement Department by August 31, 2015, unless state law specifies a longer reimbursement period.

**Do you have questions?**

If you have questions or concerns that your dealer is unable to resolve, please contact the appropriate Customer Assistance Center at the number listed below.

Division	Number	Text Telephones (TTY)
Chevrolet	1-800-222-1020	1-800-833-2438
Pontiac	1-800-762-2737	1-800-833-7668
Saturn	1-800-553-6000	1-800-833-6000
Guam	65-6267-1752	
Puerto Rico – English	1-800-496-9992	
Puerto Rico – Español	1-800-496-9993	
Virgin Islands	1-800-496-9994	

If after contacting your dealer and the Customer Assistance Center, you are still not satisfied we have done our best to remedy this condition without charge and within a reasonable time, you may wish to write the Administrator, National Highway Traffic Safety Administration, 1200 New Jersey Avenue, SE, Washington, DC 20590, or call the toll-free Vehicle Safety Hotline at 1.888.327.4236 (TTY 1.800.424.9153), or go to <http://www.safercar.gov>. The National Highway Traffic Safety Administration Campaign ID Number for this recall is 14V252.

Federal regulation requires that any vehicle lessor receiving this recall notice must forward a copy of this notice to the lessee within ten days.

Jim Moloney  
General Director,  
Customer and Relationship Services

Enclosure  
GM Recall Number: 13036